

DAVEY

DAVEY ChloroMatic
Nipper™

Salt Pool Chlorination System

Models: DNP15C, DNP25C, DNP35C,
DNP15CLS & DNP25CLS

Installation and Operating Instructions



WARNING: Failure to follow these instructions and comply with all applicable codes may cause serious bodily injury and/or property damage.

The installation of this product should be carried out by a person knowledgeable in swimming pool plumbing requirements following the installation instructions provided in this manual.

Please pass these instructions on to the operator of this equipment.

DAVEY ChloroMatic Nipper™

Congratulations! You are now the proud owner of a new ChloroMatic Nipper. Please read all information in this manual carefully before installing or operating your ChloroMatic Nipper.

Contents:

1. PACKING LIST	3
2. IMPORTANT SAFETY INSTRUCTIONS	4
3. COMMON TERMS.....	6
4. INSTALLING THE ChloroMatic Nipper	6
5. CONNECTING THE ELECTROLYTIC CELL TO THE POWER SUPPLY	7
6. CONNECTING THE FLOW SWITCH TO THE CELL HOUSING	7
7. PRE-START UP PROCEDURE.....	8
8. OPERATION OF YOUR ChloroMatic Nipper	8
9. CONTROL PANEL	9
10. INITIAL START-UP	9
11. TYPICAL (EVERYDAY) START-UP.....	14
12. ChloroMatic Nipper FEATURES	15
13. MAINTENANCE OF POWER SUPPLY	34
14. MAINTENANCE OF THE ELECTROLYTIC CELL.....	34
15. DAY TO DAY OPERATION	36
16. CHLORINE PRODUCTION	37
17. GENERAL INFORMATION.....	38
18. TROUBLE SHOOTING.....	38
19. SPARE PARTS	39



ATTENTION: Please refer to www.bit.ly/nippercm for any product information updates, or simply scan this QR code.



1. PACKING LIST

Included with your ChloroMatic Nipper are the following items, please check the contents of the box carefully prior to attempting to install the system:

- a. 1 x Power supply with cell lead;
- b. 1 x U-shaped electrolytic housing & cell;
- c. 1 x Cell blanking cap & o-ring;
- d. 2 x Barrel unions including nut, tail & o-ring;
- e. 2 x Reducing bushes;
- f. 1 x Quick reference guide;
- g. 1 x Power lead; and
- h. 1 x Mounting screws & plugs pack



Figure 1.1



ATTENTION: Your ChloroMatic Nipper is not intended for use by young children or infirm persons without supervision. Please ensure that young children are supervised to ensure that they do not play with the ChloroMatic Nipper System.



ATTENTION: Power connections and wiring must be carried out by an authorised electrician.



WARNING: This product contains a lithium button or coin battery which can only be accessed by using specialist tools.

This button/coin battery is mounted securely inside the electronic control circuitry of the power supply. Access to this battery requires the use of specialist tools and should only be undertaken by a suitably qualified technician or tradesperson.

In the unlikely event that the power supply has been dismantled, care must be taken to ensure all appropriate safety steps are undertaken including ensuring that young children or infirm persons do not have access to the button/coin battery.

If swallowed, a lithium button/coin battery can cause severe or fatal injuries within 2 hours.

If you think a button/coin battery may have been swallowed or placed inside any part of the body, seek immediate medical attention.

2. IMPORTANT SAFETY INSTRUCTIONS

- To minimise the risk of gas build-up in the cell housing, you must ensure there is sufficient water flow through the cell when the unit is on and producing chlorine.
- It is essential that your pool pump circulates sufficient water through the cell housing to completely fill the cell housing with water during the chlorination process.
- Periodically check the paddle of the safety flow switch to ensure it is free to move back and forth and that the lock nut is done up hand tight.



Diagram A

**CORRECT OPERATION
WITH A PUMP RUNNING**

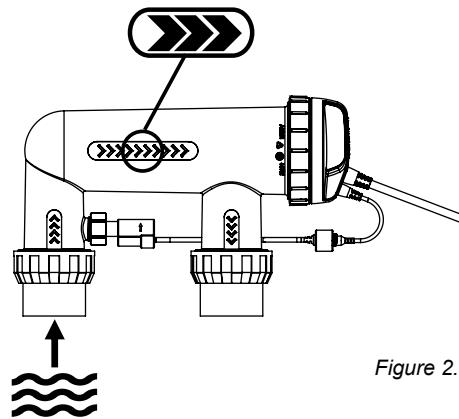

Figure 2.1



Diagram B

**INCORRECT OPERATION
WITH A PUMP RUNNING**

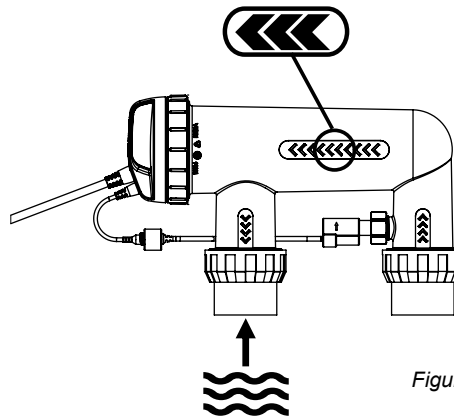

Figure 2.2

- Always check for the latest versions of installation and operation instructions that support these products. Simply scan this QR code, or go to: www.bit.ly/nippercm



IMPORTANT INFORMATION ABOUT YOUR Nipper

**FACTORS THAT WILL IMPROVE THE PERFORMANCE & LIFE OF YOUR ChloroMatic Nipper.
PLEASE READ THIS BEFORE OPERATING YOUR CHLORINATOR**

POOL BUILDERS:

Please cover this information with your customer during the new pool “Handover Session”.

Chlorinators are a valuable piece of pool equipment and must be cared for to get the best performance and life span. There are THREE main factors that will damage your ChloroMatic Nipper and reduce the life of the product. Please monitor the following factors in accordance with your installation & operating instructions.

1. MAINTAIN RECOMMENDED SALT LEVELS

RECOMMENDED OPERATING RANGE: (see page 38)

- Run your ChloroMatic Nipper at the salt levels stated within this document and on the product to ensure optimum performance and cell life;
- Operating the ChloroMatic Nipper at low salt levels will damage the cell and reduce its life;
- The control panel displays a flashing red LED indicator warning when the salt levels are low;
- If no action is taken to rectify the salt levels, damage to the cell may result which will not be covered under warranty.

2. MONITOR & MAINTAIN YOUR Nipper CELL

Nipper has a “reverse polarity” cell.

- To keep your ChloroMatic Nipper in the best possible condition, regular monitoring of the cell is recommended. The cell is in the clear plastic housing and contains the Titanium plates.
- During the chlorination process a white powdery Calcium scale may naturally build up on the Titanium plates in the cell. Monitor the cell to prevent excessive scale build up. Excessive scale build-up will cause damage to your cell, and dramatically reduce its efficiency and lifespan.
- The control panel displays a red LED indicator warning that indicates that the cell may require cleaning.
- If Calcium scale builds up please clean the cell, following the cleaning instructions provided on page 36.
- **NEVER:** Use concentrated acid to clean your cell.
- **NEVER:** Leave cell in cleaning solution for extended periods of time.
- **NEVER:** Use metal implements, scourers, or brushes to clean the cell.

3. BALANCED POOL WATER CHEMISTRY

- Correct salt levels **MUST** be maintained (see page 38) for optimum performance and lifespan.
- Calcium Hardness levels **MUST** be kept to ideal ranges of **200 - 275ppm** (for Concrete and Tiled Pools) and **100 - 225ppm** (for other surfaces) to prevent excessive scale build up and damage to equipment.
- pH levels **MUST** be kept to ideal levels to prevent damage to equipment and pool surfaces and to obtain optimum chlorination effectiveness.
- Total Alkalinity and Stabiliser levels must also be kept in an ideal range.

Note: Please refer to the POOL WATER CHEMISTRY chart on page 40 for more information.

3. COMMON TERMS

Algae	Microscopic forms of plant life which enter the pool by rain, wind and dust. There are numerous varieties – some are free floating whilst others grow on walls and in cracks and come in different colours. Some are more resistant to chemical treatment than others.
Bacteria	The germs that contaminate your pool. Introduced by swimmers, dust, rain storms and other elements.
Balanced water	The correct ratio of mineral content and pH level that prevents pool water from being corrosive or scale forming.
Chloramines	Compounds formed when chlorine combines with nitrogen from urine, perspiration, etc. Chloramines cause eye and skin irritation, as well as unpleasant odours.
Chlorine demand	The chlorine required to destroy germs, algae and other contaminants in the pool.
Chlorine residual	The amount of chlorine remaining after chlorine demand has been satisfied. This is the reading obtained with your test kit.
Cyanuric acid	Also known as stabiliser or conditioner. It reduces dissipation of chlorine by direct sunlight.
Liquid acid	Chemical used to reduce the pH and total alkalinity in the pool water, and for cleaning Sanitiser cell.
ppm	An abbreviation for Parts Per Million the accepted measurement of chemical concentration in swimming pool water. 1 ppm = 1 mg/L.

4. INSTALLING THE Nipper

4.1 INSTALLING THE POWER SUPPLY

Select a convenient well-ventilated location within one metre of filter equipment and mount the power supply vertically onto a wall, or post at least as wide as the ChloroMatic Nipper power supply itself. Mount at an appropriate height for easy access and viewing of the control panel. Davey recommends that the power supply shall not be located within 3 meters of the pool water. Plug pump and chlorinator power supply into a suitable weatherproof power outlet/controller. Where applicable, some model variants have a 3-pin socket on the rear of the power supply, provide pump power. The unit must be kept away from acid and other chemical storage areas. Acid and chemical vapours will corrode the electronics inside the unit. It must also be kept away from heat sources. Good ventilation is necessary for correct operation.

Two self-tapping screws and wall plugs have been provided for fast and simple installation.

Use a 6mm masonry drill bit when fitting Power Supply to a brick or concrete wall. When mounting to a post drill pilot holes and fit screws provided. Holes should be level and 164mm apart. Once screws are in position simply hang ChloroMatic Nipper power supply via mounts on back of unit. For adequate weatherproofing, the wall or post that ChloroMatic Nipper is mounted to, should be flat and at least as wide as the ChloroMatic Nipper power supply.

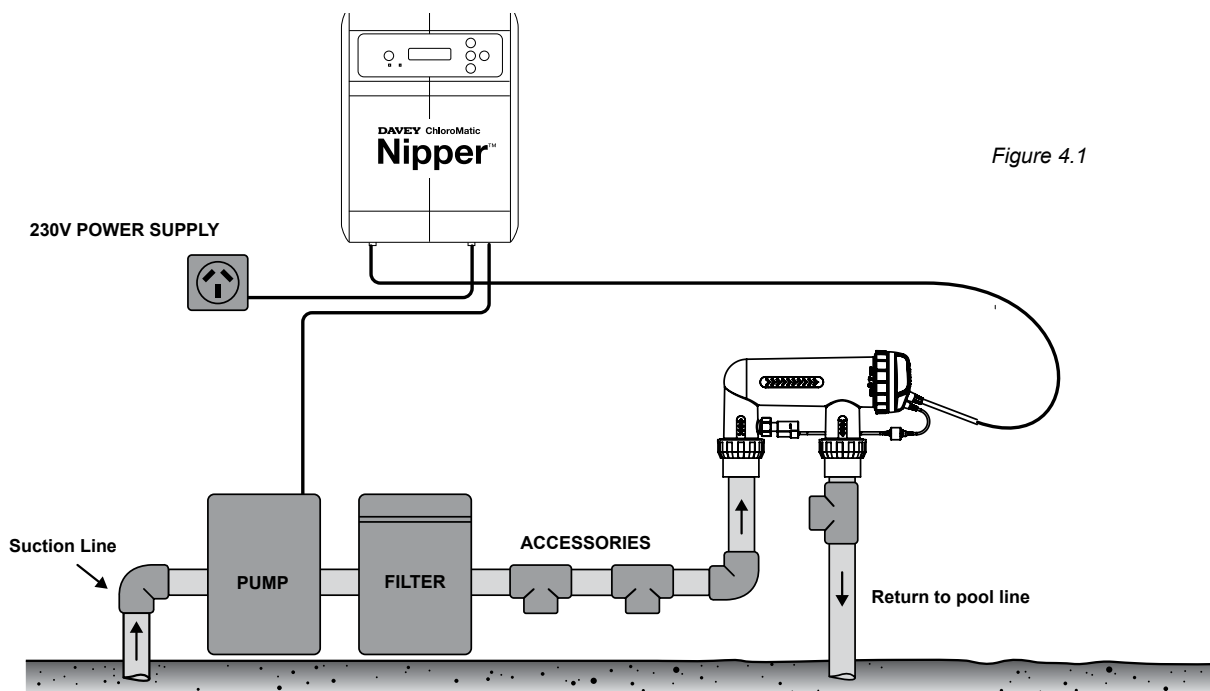

Figure 4.1

4.2 INSTALLING THE CELL

The ChloroMatic Nipper cell should always be the last appliance in your system. Ensure the cell is installed after pumps, filters and any heating appliances. To achieve best efficiency, the ChloroMatic Nipper cell should be installed such that turbulent water is limited as much as possible. When installing a 90° elbow before the cell's inlet barrel union, ensure there's equivalent to 5 x pipe diameter of straight pipe between the elbow and the union. **That is, if the pipe diameter is 40mm, straight pipe entering the barrel union should be no less than 200mm in length.** Isolation valves (used where equipment is located below pool water level) should also be installed no closer than 5 x pipe diameter from the inlet barrel union. This will assist laminar flow.

5. CONNECTING THE ELECTROLYTIC CELL TO THE POWER SUPPLY

The Nipper salt water sanitiser uses a reverse polarity electrolytic cell for low maintenance operation. The ChloroMatic Nipper power supply is fitted with a flexible lead terminated with the cell connectors built into a plastic moulding. The three in-line connectors are not "polarity sensitive".

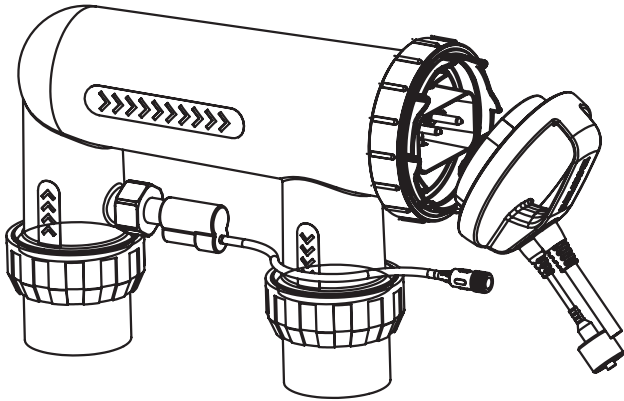

Figure 5.1

NOTE: The ChloroMatic Nipper cell is supplied with a paddle type flow switch, which is to be installed on the cell as shown in the diagram on page 4 and connected to the cell lead via the connector on the end of the cable.



IMPORTANT: The flow switch must be mounted with the highlighted arrow on side of the switch pointing in the direction of flow.

6. CONNECTING THE FLOW SWITCH TO THE CELL HOUSING

Ensure that the flow switch is installed into the cell housing.

Ensure the flow switch direction is correct (see page 4)

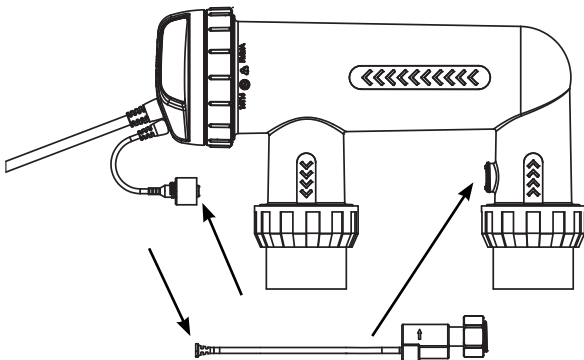

Figure 6.1

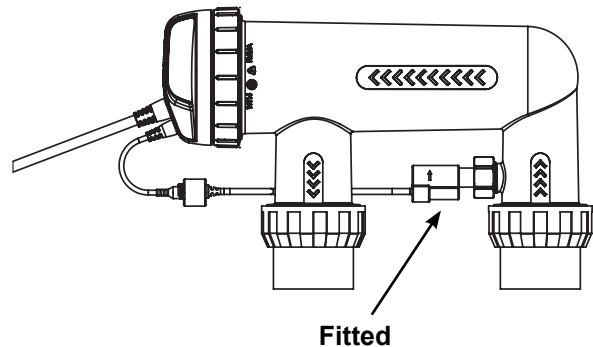

Figure 6.2

7. PRE-START UP PROCEDURE

Before operating your ChloroMatic Nipper salt pool chlorination system, please ensure the following quantity of pool salt has been added to your pool.

- **POOL SALT:**

To raise salt concentration by		Salt required															
		30,000L		40,000L		50,000L		60,000L		70,000L		80,000L		90,000L		100,000L	
ppm	%	kg	lbs	kg	lbs	kg	lbs	kg	lbs	kg	lbs	kg	lbs	kg	lbs	kg	lbs
1,000	0.1	30	66	40	88	50	110	60	132	70	154	80	176	90	198	100	220
2,000	0.2	60	132	80	176	100	220	120	265	140	309	160	353	180	397	200	441
3,000	0.3	90	198	120	265	150	331	180	397	210	463	240	529	270	595	300	661
4,000	0.4	120	265	160	353	200	441	240	529	280	617	320	705	360	794	400	882
5,000	0.5	150	331	200	441	250	551	300	661	350	772	400	882	450	992	500	1,102
6,000	0.6	180	397	240	529	300	661	360	794	420	926	480	1,058	540	1,190	600	1,323

- **CHLORINE:** For a new pool installation that has not been chlorinated, add sufficient Chlorine (liquid or granular) to achieve a reading of 3 ppm (with a suitable test kit). Alternatively, run the ChloroMatic Nipper salt pool chlorination system continuously on **BOOST MODE**, for approximately 24 hours, or until a reading of 3 ppm is reached.
- **STABILISER:** It is essential that pool stabiliser be added and maintained at the rate of 25 - 50 ppm at all times (**FOR OUTDOOR POOLS ONLY**). For ORP controlled systems the stabiliser level should be maintained between 15-25ppm.
- (Refer Day to Day Operation section 15 for further information).

8. OPERATION OF YOUR Nipper

CHLORINE OUTPUT is expressed as a percentage of the maximum output of the ChloroMatic Nipper. Set the ChloroMatic Nipper to the percentage output required and the unit will automatically adjust the cell output to the set level. The ChloroMatic Nipper is fitted with an electronic control and warning system. This regulates the output of the ChloroMatic Nipper to the pre-set maximum and changes cell polarity. The polarity will alternate over a number of hours of chlorination time, not necessarily pump-run hours.

9. CONTROL PANEL

9.1 LAYOUT



Figure 9.1



Manual on/off



Power indicator
(lit when Nipper on)



Menu up/down



Alarm indicator
(flashes when alarm active)



Menu/setting select

Time out

(whenever device is left for 30 seconds without input from user, settings are saved, and home screen displayed)



Menu/setting cancel (go back)

10. INITIAL START-UP

Once the salt level in the pool is correct the unit may be switched on.

Note: Once the unit starts there is a short time delay until the cell operates to ensure the filtration system is primed with water.

- The first time the ChloroMatic Nipper is turned on, the following screen is shown on start-up:



Figure 10.1

- > This screen shows the version of software (ie v1.2.1 shown) and your model of ChloroMatic Nipper (ie AU 15 shown, meaning DNP15C).

- The display then automatically reverts to the following screen:



Figure 10.2

- > This screen shows the language menu and the current language setting (ie English shown);
- > The language setting can be changed by pressing the ▲▼ menu up/down buttons to scroll through available languages;
- > Press ● menu/setting select once your preferred language is displayed;
- > If a mistake is made, the setting can be changed later.
- The display then automatically reverts to the following screen:



Figure 10.3

- > This screen shows the time format menu and the current time format (ie 12HR shown);
- > The time format can be changed by pressing the ▲▼ menu up/down buttons to toggle between 12HR and 24HR formats;
- > Press ● menu/setting select once your preferred time format is displayed;
- > If a mistake is made, the setting can be changed later.
- The display then automatically reverts to the following screen:

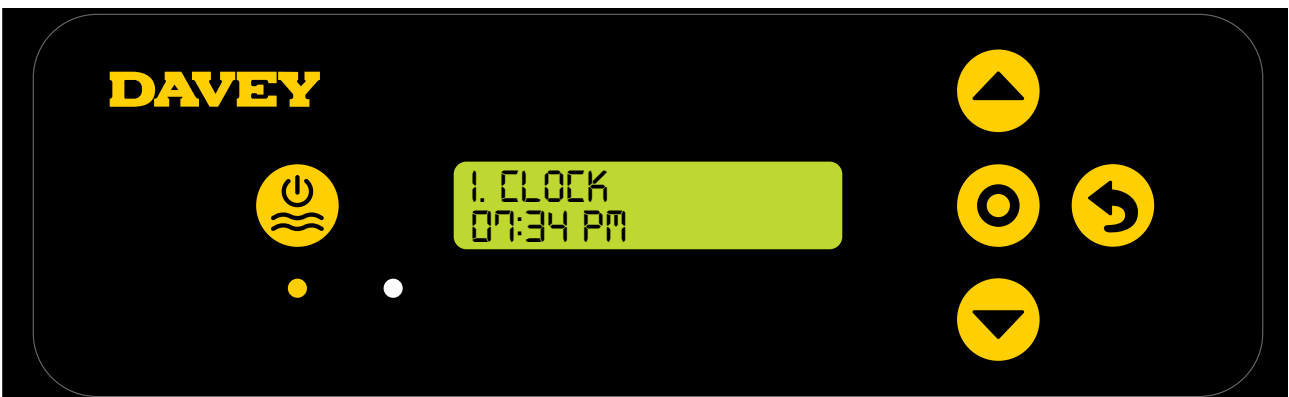

Figure 10.4

- > This screen shows the clock's current time (Figure 10.4 shows 07:34PM, having elected for 12 hour time format earlier);

- > Initially the clock hours will be flashing;
- > The clock hours can be changed by pressing the ▲▼ menu up/down buttons to scroll to your chosen time;
- > Press ⓪ menu/setting select once your preferred clock hour is displayed;
- > If a mistake is made, the setting can be changed later.
- > Next the clock minutes will be flashing;
- > The clock minutes can be changed by pressing the ▲▼ menu up/down buttons to scroll to your chosen time;
- > Press ⓪ menu/setting select once your preferred clock minutes is displayed;
- > If a mistake is made, the setting can be changed later.
- > Next the clock AM/PM will be flashing (if 12 hour time format chosen earlier. Otherwise, the display reverts to date format menu);
- > The clock AM/PM can be changed by pressing the ▲▼ menu up/down buttons to toggle between AM and PM;
- > Press ⓪ menu/setting select once your preferred clock AM/PM is displayed;
- > If a mistake is made, the setting can be changed later.
- The display then automatically reverts to the following screen:

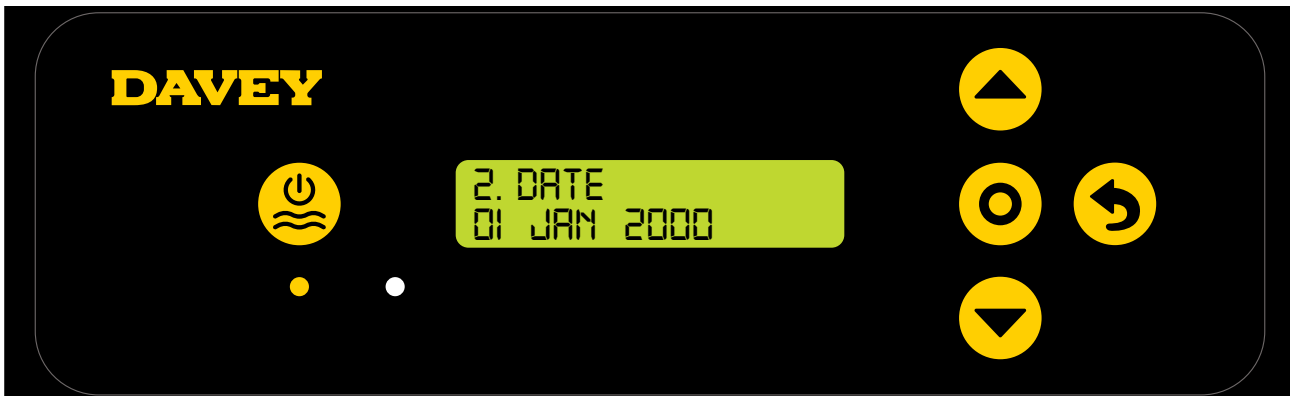

Figure 10.5

- > This screen shows the date format menu and the current date (ie 01 JAN 2000 shown);
- > Initially the date day will be flashing;
- > The date day can be changed by pressing the ▲▼ menu up/down buttons to scroll to your chosen date day;
- > Press ⓪ menu/setting select once your preferred date day is displayed;
- > If a mistake is made, the setting can be changed later.
- > Next the date month will be flashing;
- > The date month can be changed by pressing the ▲▼ menu up/down buttons to scroll to your chosen date month;
- > Press ⓪ menu/setting select once your preferred date month is displayed;
- > If a mistake is made, the setting can be changed later.
- > Next the date year will be flashing;
- > The date year can be changed by pressing the ▲▼ menu up/down buttons to scroll to your chosen date year;
- > Press ⓪ menu/setting select once your preferred date year is displayed;
- > If a mistake is made, the setting can be changed later.

- The display then automatically reverts to the **HOME** screen:



Figure 10.6

> The screen shows the **ON-TIME** of **TIMER 1**:

- current **ON-TIME** of **TIMER 1** is 6:00am (assuming 12 hour time format chosen earlier).

> Initially the clock hours will be flashing;

> The clock hours can be changed by pressing the **▲▼** menu up/down buttons to scroll to your chosed time;

> Press **⊙** menu/setting select once your preferred clock hour is displayed;

> If a mistake is made, the setting can be changed later;

> Next, the clock minutes will be flashing;

> The clock minutes can be changed by pressing the **▲▼** menu up/down buttons to scroll to your chosen time;

> Press **⊙** menu/setting select once your preferred clock minutes is displayed;

> If a mistake is made, the setting can be changed later;

> Next, the clock AM/PM will be flashing;

> The clock AM/PM can be changed by pressing the **▲▼** menu up/down buttons to toggle between AM and PM;

> Press **⊙** menu/setting select once your preferred clock AM/PM is displayed;

> If a mistake is made, the setting can be changed later;

> Press **▲▼** menu up/down buttons

- The display then automatically reverts to the following screen:



Figure 10.7

> The screen shows the **OFF-TIME** of **TIMER 1**:

- current **OFF-TIME** of **TIMER 1** is 9:00am (assuming 12 hour time format chosen earlier).

> Initially the clock hours will be flashing;

- > The clock hours can be changed by pressing the ▲▼ menu up/down buttons to scroll to your chosen time;
- > Press ⓪ menu/setting select once your preferred clock hour is displayed;
- > If a mistake is made, the setting can be changed later;
- > Next, the clock minutes will be flashing;
- > The clock minutes can be changed by pressing the ▲▼ menu up/down buttons to scroll to your chosen time;
- > Press ⓪ menu/setting select once your preferred clock minutes is displayed;
- > If a mistake is made, the setting can be changed later;
- > Next, the clock AM/PM will be flashing (assuming 12 hour format chosen earlier);
- > The clock AM/PM can be changed by pressing the ▲▼ menu up/down buttons to toggle between AM and PM;
- > Press ↶ menu/setting cancel (go back) button once your preferred OFF-TIME for **TIMER 1** is displayed;
- > If a mistake is made, the setting can be changed later;
- The display then automatically reverts to the following screen:

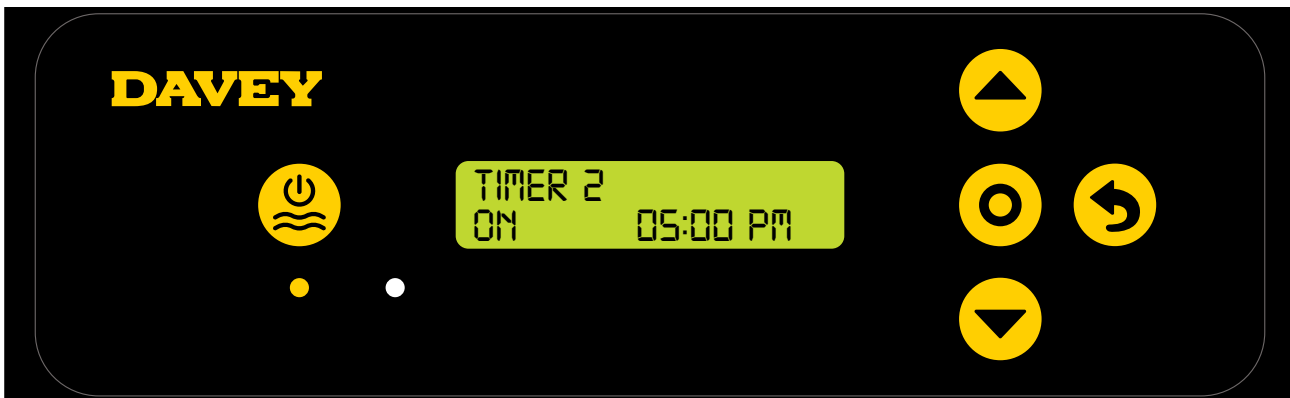

Figure 10.8

- > The screen shows the **ON-TIME** of **TIMER 2**:
 - current **ON-TIME** of **TIMER 2** is 5:00pm.
- > Initially the clock hours will be flashing;
- > The clock hours can be changed by pressing the ▲▼ menu up/down buttons to elect your respective times and press ⓪ menu/setting select to enter through the menu.
- > If a mistake is made, the setting can be changed later;
- The display then automatically reverts to the following screen:

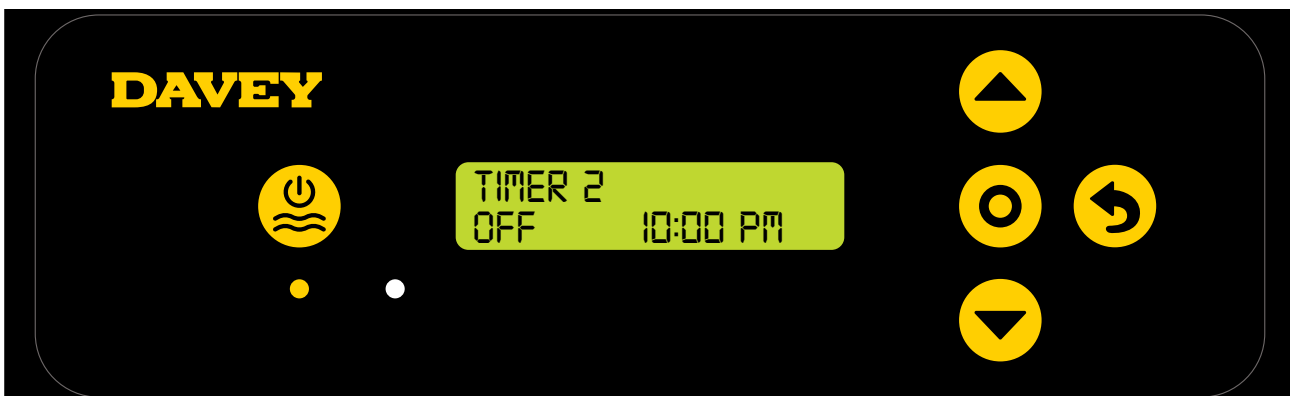

Figure 10.9

- > The screen shows the **OFF-TIME** of **TIMER 2**:
 - current **OFF-TIME** of **TIMER 2** is 10:00pm.
- > Initially the clock hours will be flashing;
- > As before, use the ▲▼ menu up/down buttons to elect your respective times and press ⏻ menu/setting select to enter through the menu.
- > If a mistake is made, the setting can be changed later;
- The display then automatically reverts to the **HOME** screen:



Figure 10.10

- > This screen shows the:
 - current chlorine output setting (ie 100% shown);
 - current time setting;
 - current power status (ie ON shown).

11. TYPICAL (EVERYDAY) START-UP

Note: Once the unit starts there is a short time delay until the cell operates to ensure the filtration system is primed with water.

- Every time the ChloroMatic Nipper is turned on, the following screen is shown on start-up:



Figure 11.1

- The display then automatically reverts to the **HOME** screen:

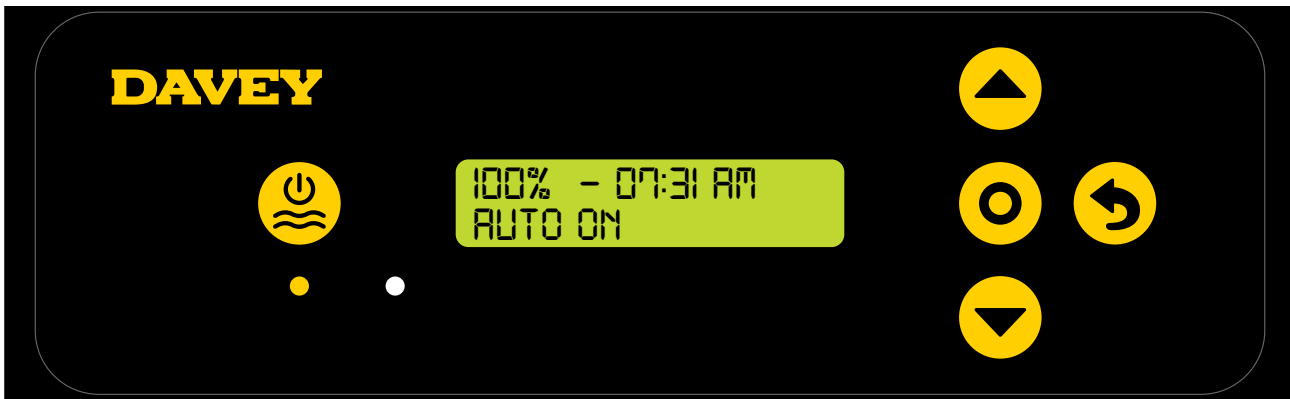

Figure 11.2

> This screen shows the:

- current chlorine output setting (ie 100% shown);
- current time setting;
- current power status:

AUTO ON: (ie as shown above) indicates the ChloroMatic Nipper is currently operating within the **ON-TIME** of either **TIMER 1**, or **TIMER 2**;

AUTO: indicates the ChloroMatic Nipper is powered but is within the **OFF-TIME** of both **TIMER 1**, and **TIMER 2**;

MANUAL ON: indicates the ChloroMatic Nipper is currently operating, having been manually overridden;

MANUAL OFF: indicates the ChloroMatic Nipper is powered but is not currently operating, having been manually overridden.

12. ChloroMatic Nipper FEATURES

12.1 CONTROLLING CHLORINE OUTPUT



Figure 12.1

The **CHLORINE OUTPUT** controls the time that the cell is producing chlorine, as a percentage of total time that the ChloroMatic Nipper is on. If the ChloroMatic Nipper cell is producing, it is producing at 100%, unless otherwise altered (see sections **WINTER MODE**, or **SPA MODE**). The cell run time is referred to as “cell duty cycle”.

For example:

- If the ChloroMatic Nipper is on for 8 hours per day, and the **CHLORINE OUTPUT** is set to 50%: the ChloroMatic Nipper cell duty cycle is only 4 hours, of that day;
- If the ChloroMatic Nipper is on for 8 hours per day, and the **CHLORINE OUTPUT** is set to 25%: the ChloroMatic Nipper cell duty cycle is only 2 hours, of that day.

To adjust the **CHLORINE OUTPUT**:

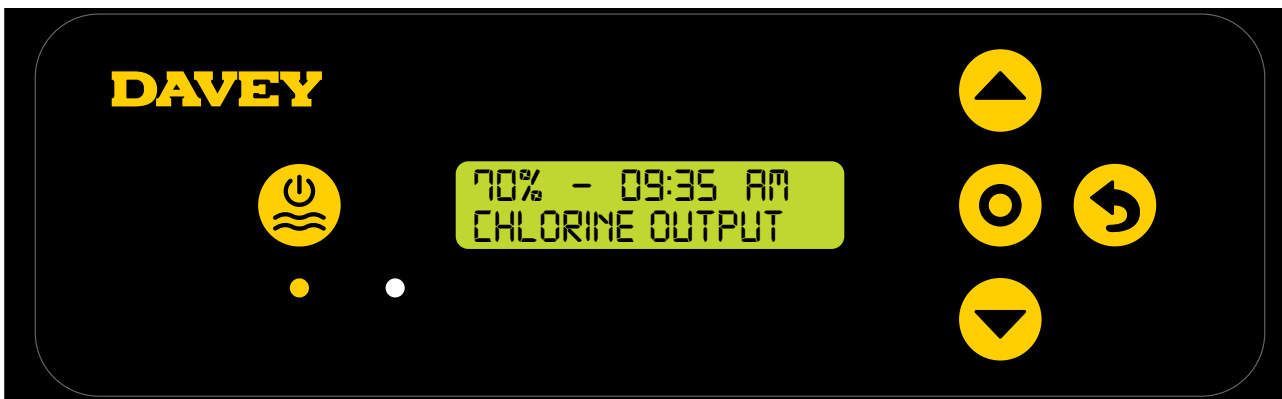



Figure 12.2

- > Press the  menu up/down buttons to scroll to your chosen **CHLORINE OUTPUT**;
- > The setting will change the cell duty cycle by 5% increments;
- > Press  menu/setting select once your preferred **CHLORINE OUTPUT** is displayed;
- > This will then take you back to the **HOME** screen.

12.2 AUTOMATED TIMERS

The ChloroMatic Nipper has two separate timers available for automated operation. This is ideal if looking to run the pool a few hours in the morning, then a few hours in the afternoon. It is important to ensure that the timers do not overlap as this may create confusion when the timer turns on and off.

To adjust **ON-TIME** of **TIMER 1**:

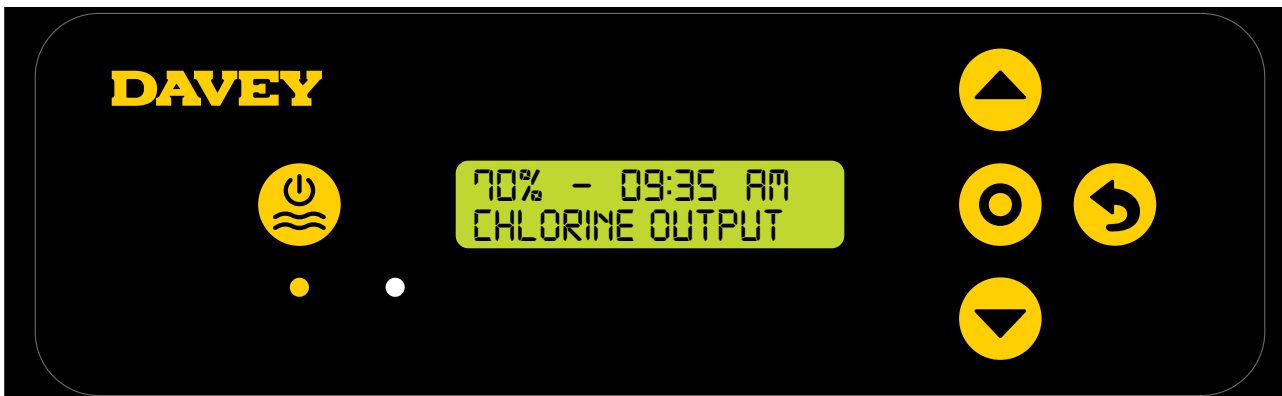



Figure 12.3

- > From the **HOME** screen, press  menu/setting select;
- > The display will show this screen:

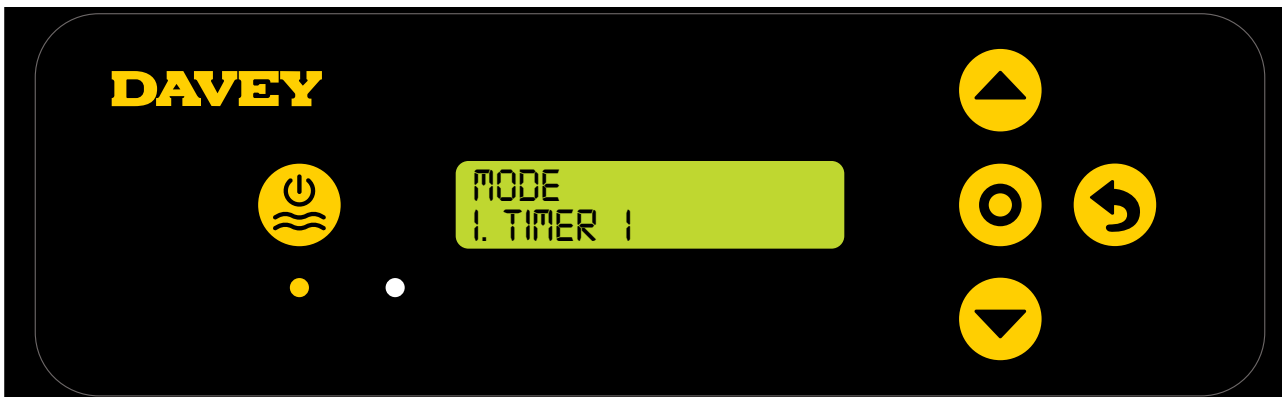

Figure 12.4

> From this screen, press  **menu/setting select** to enter **TIMER 1** menu;





Figure 12.5

> The screen shows the **ON-TIME** of **TIMER 1**:

- current **ON-TIME** of **TIMER 1** is 6:00am (example assumes 12 hour time format chosen).

> Initially the clock hours will be flashing;

> Use the   **menu up/down** buttons to change the time values. Press the  **menu/setting select** to enter through the menu.

> If a mistake is made, the setting can be changed later;

> Press  **menu/setting cancel (go back)** button once your preferred **ON-TIME** for **TIMER 1** is displayed. This will take you back to the **HOME SCREEN**.

To adjust **OFF-TIME** of **TIMER 1**:

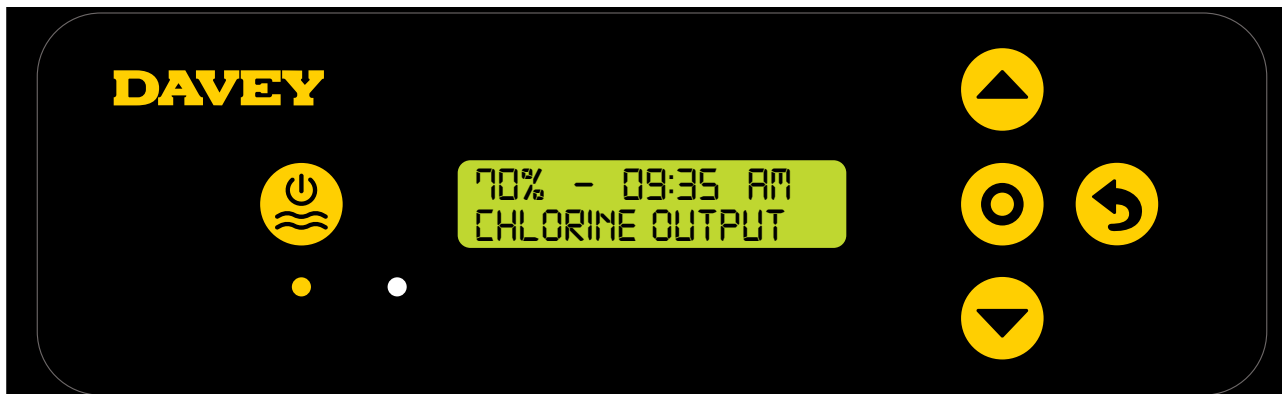

Figure 12.6

> From the **HOME** screen, press  **menu/setting select**;

> The display will show this screen:



Figure 12.7

> From this screen, press  **menu/setting select** to enter **TIMER 1** menu;



Figure 12.8

> Using the ▲▼ menu up/down buttons scroll to the **OFF-TIME** of **TIMER 1**.

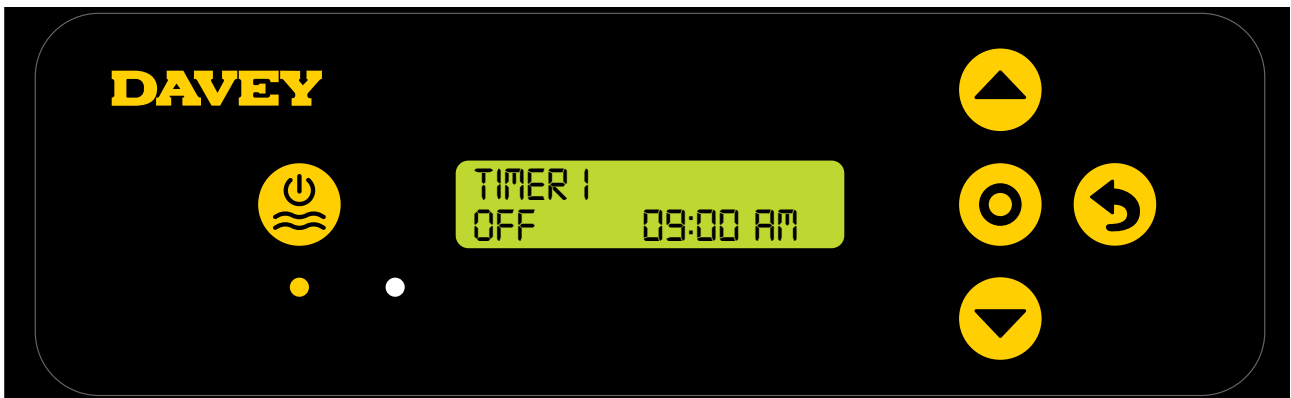

Figure 12.9

> The screen shows the **OFF-TIME** of **TIMER 1**:

- current **OFF-TIME** of **TIMER 1** is 9:00am (example assumes 12 hour time format chosen).

> Initially the clock hours will be flashing;

> Use the ▲▼ menu up/down buttons to change the time values. Press the ● menu/setting select to enter through the menu.

> Press ↶ menu/setting cancel (go back) button once your preferred **OFF-TIME** for **TIMER 1** is displayed; This will take you back to the **HOME SCREEN**.

To adjust both **ON-TIME** and **OFF-TIME** of **TIMER 2**:



Figure 12.10

> From the **HOME** screen, press ● menu/setting select;

> The display will show this screen:



Figure 12.11

> Using the  menu up/down buttons scroll to the **TIMER 2** menu.



Figure 12.12

> From this screen, press  menu/setting select to enter **TIMER 2** menu;

> To adjust both the **ON-TIME** and **OFF-TIME** for **TIMER 2**, follow the same steps shown previously for **TIMER 1**.

12.3 ACTIVATING COVER MODE

A pool's exposure to UV contributes significantly to the pool's total chlorine demand. Ie the amount of chlorine the pool uses. Excessive amounts of chlorine in a pool with a cover on, can significantly shorten the life expectancy of the pool cover, if left for long periods of time (eg weeks). Turning on the **COVER MODE** reduces the cell duty cycle by 80% of its current setting.

For example:

- If the ChloroMatic Nipper is on for 8 hours per day, the **CHLORINE OUTPUT** is set to 50%, but the **COVER MODE** is on: the ChloroMatic Nipper cell duty cycle is only 48 minutes, of that day;
- If the ChloroMatic Nipper is on for 8 hours per day, the **CHLORINE OUTPUT** is set to 25%, but the **COVER MODE** is on: the ChloroMatic Nipper cell duty cycle is only 24 minutes, of that day.

To turn on **COVER MODE**:



Figure 12.13

- > From the **HOME** screen, press  **menu/setting select**.
- > The display will show this screen:



Figure 12.14

- > Use the  **menu up/down** buttons to scroll to the **COVER MODE** menu:



Figure 12.15





- > From this screen, press  **menu/setting select** to enter **COVER MODE** menu;
- > The display will show the current **COVER MODE** setting (ie **COVER MODE** off shown):



Figure 12.16

- > Press  **menu up/down** buttons to toggle between **COVER MODE** on and off;
- > Press  **menu/setting select** once your preferred **COVER MODE** is displayed;
- > This will then take you back to the first setting menu;
- > If the ChloroMatic Nipper is left untouched for ~ 30 seconds, or the  **menu/setting cancel (go back)** button is pushed, the display reverts to the **HOME** screen.



COVER MODE can also be triggered remotely by an automated pool cover controller. By closing the terminal block contacts on the rear of the power supply, the ChloroMatic Nipper will remotely switch to **COVER MODE**. This can be overridden by user intervention, by following the steps explained previously.

12.4 ACTIVATING BOOST MODE

Should the pool experience a heavy bather load, debris/contamination, or extreme warm weather, there may be a need to super-chlorinate the pool. Turning on the **BOOST MODE** increases the cell duty cycle to 100% and overrides the cell current (output) to 100% for a period of 24 hours.

To turn on **BOOST MODE**:



Figure 12.18

> From the **HOME** screen, press  menu/setting select.

> The display will show this screen:



Figure 12.19

> Press the  menu up/down buttons to scroll to **BOOST MODE**;



Figure 12.20

> Press  menu/setting select;



Figure 12.21

> The display will show the current **BOOST MODE** setting (ie **BOOST MODE** off shown);



> Press the  menu up/down buttons to toggle between **BOOST MODE** on and off;



Figure 12.22

- > Press  **menu/setting select** once your preferred **BOOST MODE** is displayed;
- > This will then take you back to the first setting menu;
- > If the Nipper is left untouched for ~ 30 seconds, or the  **menu/setting cancel (go back)** button is pushed, the display reverts to the **HOME** screen.

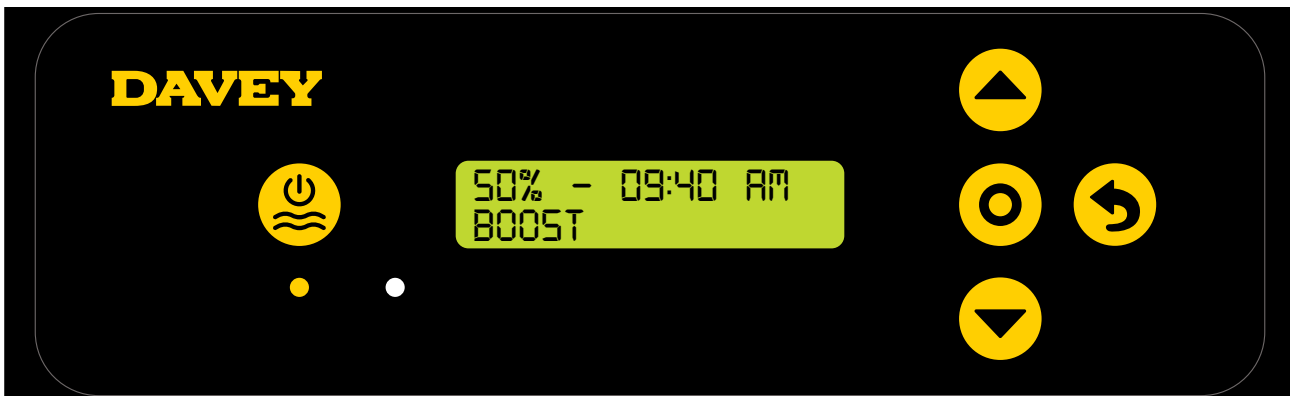

Figure 12.23

- > The **HOME** screen will continue to show the cell duty cycle percentage, however the reference to “MANUAL ON” has been notably replaced by the reference to “BOOST”. This will remain for the 24 hour period;
- > It is possible to alter the cell duty cycle during a 24-hour boost and the display percentage on the **HOME** screen changes as expected. This could be handy if the setting needs altering for the next day, once the **BOOST MODE** is finished;
- > It should be noted though, **BOOST MODE** overrides every other setting. During the 24 hour period while is **BOOST MODE** is active, the cell current is 100% output, and duty cycle is overridden to 100%. This is regardless of the display on the screen.

12.5 ACTIVATING SPA MODE

The ChloroMatic Nipper system is compatible with large swimming pool applications as well as much smaller spa applications. Turning on the SPA MODE reduces the cell duty cycle by 80% of its current setting.

For example:

- If the ChloroMatic Nipper is on for 10 hours per day, the **CHLORINE OUTPUT** is set to 50%, but the **SPA MODE** is on: the ChloroMatic Nipper cell duty cycle is only 1 hour, of that day;
- If the ChloroMatic Nipper is on for 10 hours per day, the **CHLORINE OUTPUT** is set to 25%, but the **spa MODE** is on: the ChloroMatic Nipper cell duty cycle is only 30 minutes, of that day.

To turn on **SPA MODE**:



Figure 12.24

- > From the **HOME** screen, press  **menu/setting select**.

> The display will show this screen:



Figure 12.25

> Press the ▲▼ menu up/down buttons to scroll to **SPA MODE**;



Figure 12.26

> From this screen, press ● menu/setting select to enter **SPA MODE** menu;

> The display will show the current **SPA MODE** setting (ie **SPA MODE** off shown):



Figure 12.27

> Press ▲▼ menu up/down buttons to toggle between **SPA MODE** on and off;

> Press ● menu/setting select once your preferred **SPA MODE** is displayed;

> This will then take you back to the first setting menu;

> If the ChloroMatic Nipper is left untouched for ~ 30 seconds, or the ↶ menu/setting cancel (go back) button is pushed, the display reverts to the **HOME** screen.

12.6 ACTIVATING SPA MODE AND COVER MODE SIMULTANEOUSLY

Should it be necessary to run **SPA MODE** and **COVER MODE** simultaneously, the cell duty cycle is only reduced by 80%. That is, the cell duty cycle isn't reduced by 80%, followed by a further 80%. The **HOME** screen display will toggle between showing **COVER** and **SPA**.

12.7 ACTIVATING WINTER MODE

A pool's exposure to UV contributes significantly to the pool's total chlorine demand. In the amount of chlorine the pool uses. Bather load is also a significant contributor to the pool's total chlorine demand. In winter, the pool's chlorine demand is typically far less. Unless otherwise altered, if the cell is producing chlorine, it is producing at 100% current (output). **WINTER MODE** reduces the cell's current (output) to 85%.

For example:

- If the ChloroMatic Nipper is on for 10 hours per day, the **CHLORINE OUTPUT** is set to 100%, the **WINTER MODE** is off: the ChloroMatic Nipper cell duty cycle is 10 hours. The cell current will be operating at 100% capacity;
- If the ChloroMatic Nipper is on for 10 hours per day, the **CHLORINE OUTPUT** is set to 100%, but the **WINTER MODE** is on: while the ChloroMatic Nipper cell duty cycle is still 10 hours, the cell current will only be operating at 85% capacity.

To turn on **WINTER MODE**:

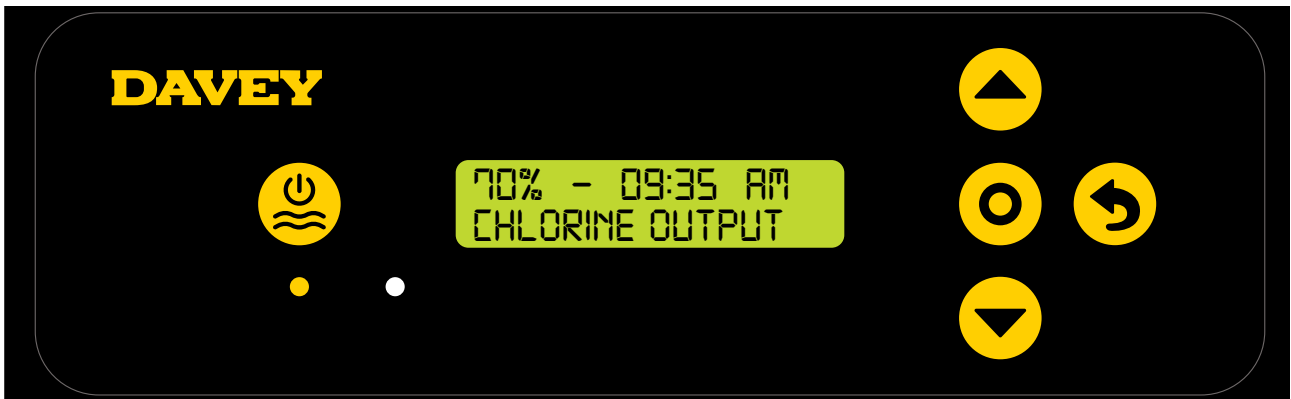



Figure 12.28

- > From the **HOME** screen, press  **menu/setting select**.
- > The display will show this screen:

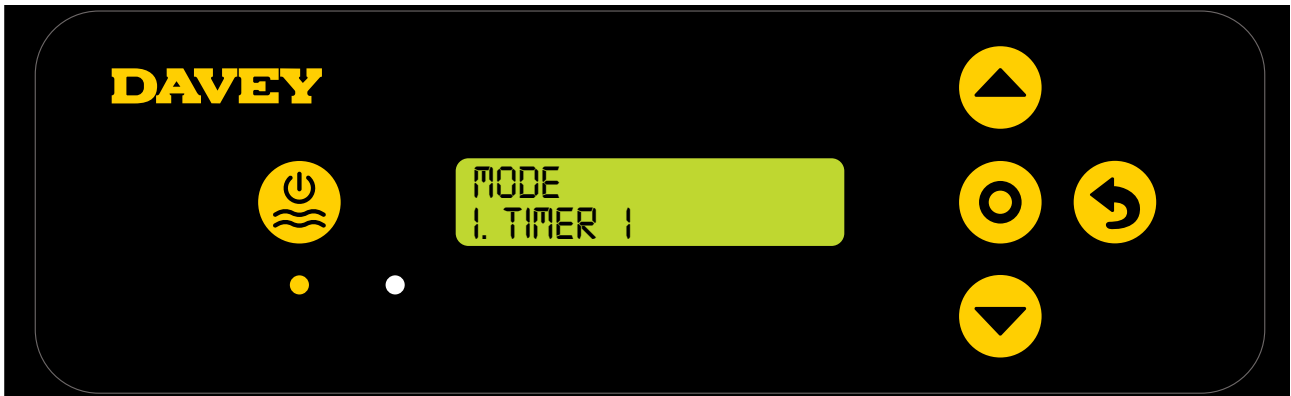

Figure 12.29

- > Press the  **menu up/down** buttons to scroll to **WINTER MODE**;





Figure 12.30

- > From this screen, press  **menu/setting select** to enter **WINTER MODE** menu;

> The display will show the current **WINTER MODE** setting (ie **WINTER MODE** off shown):



Figure 12.31

- > Press  **menu up/down** buttons to toggle between **WINTER MODE** on and off;
- > Press  **menu/setting select** once your preferred **WINTER MODE** is displayed;
- > This will then take you back to the first setting menu;
- > If the ChloroMatic Nipper is left untouched for ~ 30 seconds, or the  **menu/setting cancel (go back)** button is pushed, the display reverts to the **HOME** screen.

12.8 LOW FLOW ALARM

Should the ChloroMatic Nipper flow switch register a flow rate below 4.8m³/h (80L/min), the ChloroMatic Nipper will automatically enter **LOW FLOW ALARM**:



Figure 12.32

In **LOW FLOW ALARM**, the ChloroMatic Nipper will not produce chlorine. Once the flow switch registers flow above 4.8m³/h (80L/min), the ChloroMatic Nipper will return to normal operation. To achieve best efficiency, the ChloroMatic Nipper cell should be installed such that turbulent water is limited as much as possible. Do not install a 90° elbow closer than 200mm from the cell's inlet barrel union. Isolation valves used where equipment is located below pool water level, should also be installed no closer than 200mm from inlet barrel union. This will assist laminar flow. Should the ChloroMatic Nipper register low flow for longer than 2 minutes, the ChloroMatic Nipper will turn off the power to the pool pump (assuming it's plugged into the back of the ChloroMatic Nipper). To override the low flow alarm (after pump shutdown), the manual on/off button will need to be pushed by user.

12.9 ADD SALT ALARM

Should the ChloroMatic Nipper register low conductivity within the cell, the ChloroMatic Nipper will enter **ADD SALT ALARM**. This could be triggered by cold water (below 15°C), or a water salt concentration below it's minimum (refer to recommended salt range section in the manual). Additional salt may be added to overcome a lower temperature. However, the maximum salt level should also be considered and if water temperature drops too far, the system should be turned off.

If no action is taken and the salt level continues to be low, damage to the system may result.

It is the responsibility of the owner to ensure adequate salt levels are maintained all year round.



Figure 12.33

Once the ChloroMatic Nipper registers a salt concentration within range (refer to recommended salt range section in the manual), the ChloroMatic Nipper will return to normal operation.

12.10 LOW SALT CUT-OUT ALARM (Firmware versions prior to 2.1.5 only)

Should the salt concentration continue to be diluted, the ChloroMatic Nipper will enter **LOW SALT CUT-OUT ALARM**.



Figure 12.34

Once the salt concentration is corrected, the **LOW SALT CUT-OUT ALARM** must be reset by pushing the  **manual ON/OFF** button. Alternatively, the ChloroMatic Nipper will conduct a system check automatically when powered up the next time (if operating via a separate power supply). Upon start-up if the ChloroMatic Nipper registers a salt concentration within range (refer to recommended salt range section in the manual), the ChloroMatic Nipper will return to normal operation.

LOW SALT CUT-OUT ALARM is triggered at the following (approximate) salt concentrations:

ChloroMatic Nipper model	Low salt cut-out alarm (approx. salt concentration)
DNP15CLS, DNP25CLS	1,200ppm
DNP15C, DNP25C, DNP35C	2,500ppm

12.11 CHECK POOL CHEM ALARM

If the Chloromatic Nipper registers unusual cell behavior it will enter **CHECK POOL CHEM ALARM**. This could be triggered by unbalanced water chemistry. Davey recommends that you get a full water test at your local pool shop to identify the cause of the issue. Once the pool chemistry is corrected, the **CHECK POOL CHEM ALARM** must be reset by pushing the  **manual ON/OFF** button. Alternatively, the ChloroMatic Nipper will conduct a system check automatically when powered up the next time (if operating via a separate power supply).

12.12 OVERRIDING CLOCK SETTING

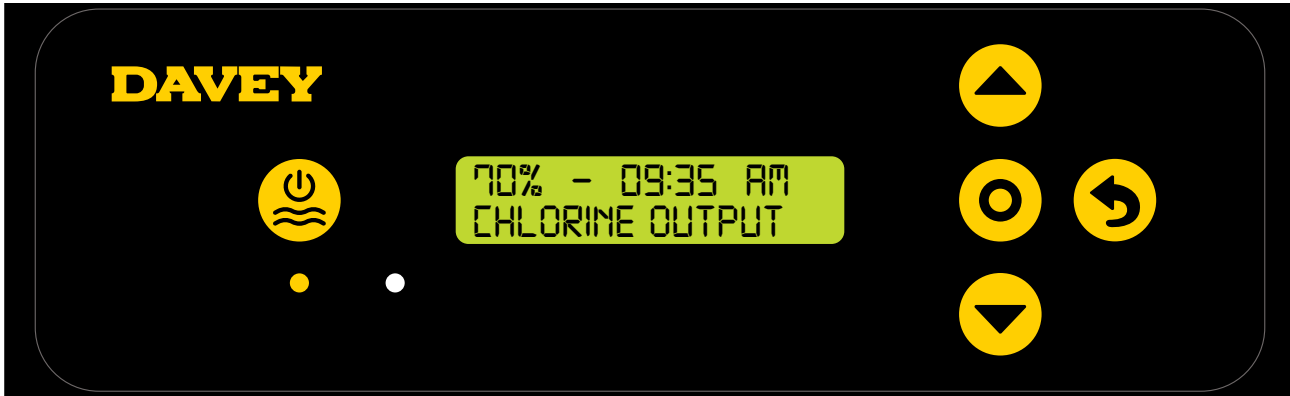

Figure 12.35

> From the **HOME** screen, press and hold  **menu/setting select** for 3 seconds.



Figure 12.36





> Press  **menu/setting select**;
> The display will show this screen.



Figure 12.37

- > This screen shows the clock's current time (ie 11:21AM shown);
- > Initially the clock hours will be flashing;
- > The clock hours can be changed by pressing the  **menu up/down** buttons to scroll to your chosen time;
- > Press  **menu/setting select** once your preferred clock hour is displayed;
- > If a mistake is made, the setting can be changed later;
- > Next, the clock minutes will be flashing;
- > The clock minutes can be changed by pressing the  **menu up/down** buttons to scroll to your chosen time;
- > Press  **menu/setting select** once your preferred clock minutes is displayed;

- > If a mistake is made, the setting can be changed later;
- > Next, the clock AM/PM will be flashing;
- > The clock AM/PM can be changed by pressing the ▲▼ menu up/down buttons to toggle between AM and PM;
- > Press Ⓞ menu/setting select once your preferred clock AM/PM is displayed;
- > If a mistake is made, the setting can be changed later;
- > If the ChloroMatic Nipper is left untouched for ~ 30 seconds, or the ↶ menu/setting cancel (go back) button is pushed, the display reverts to the HOME screen.

12.13 OVERRIDING DATE SETTING

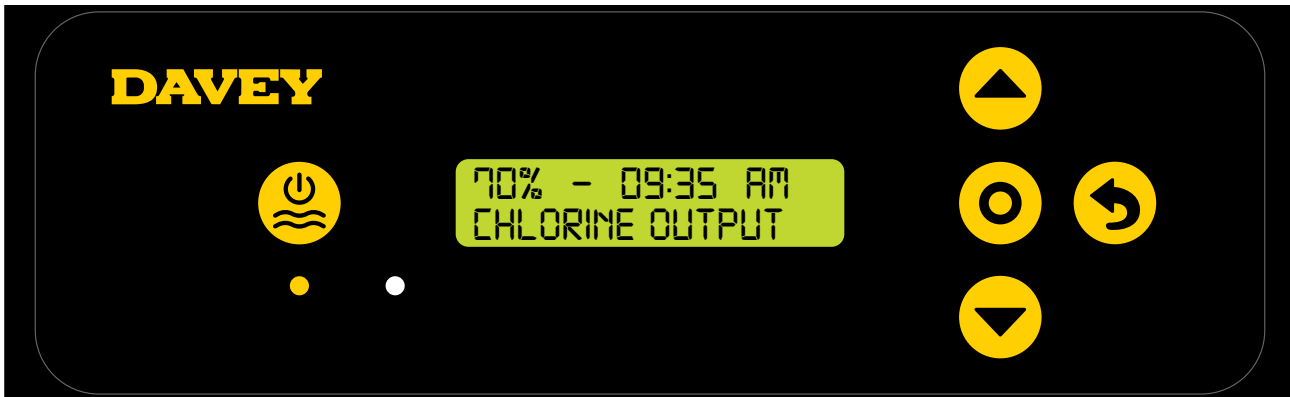

Figure 12.38

- > From the HOME screen, press and hold Ⓞ menu/setting select for 3 seconds.

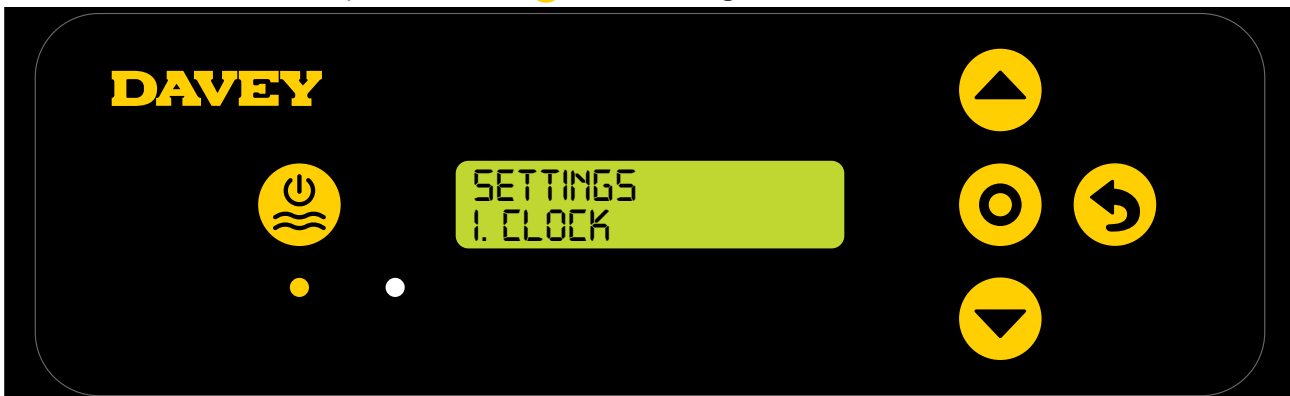

Figure 12.39

- > Press the ▲▼ menu up/down buttons to scroll down to DATE menu;



Figure 12.40

- > Press Ⓞ menu/setting select;

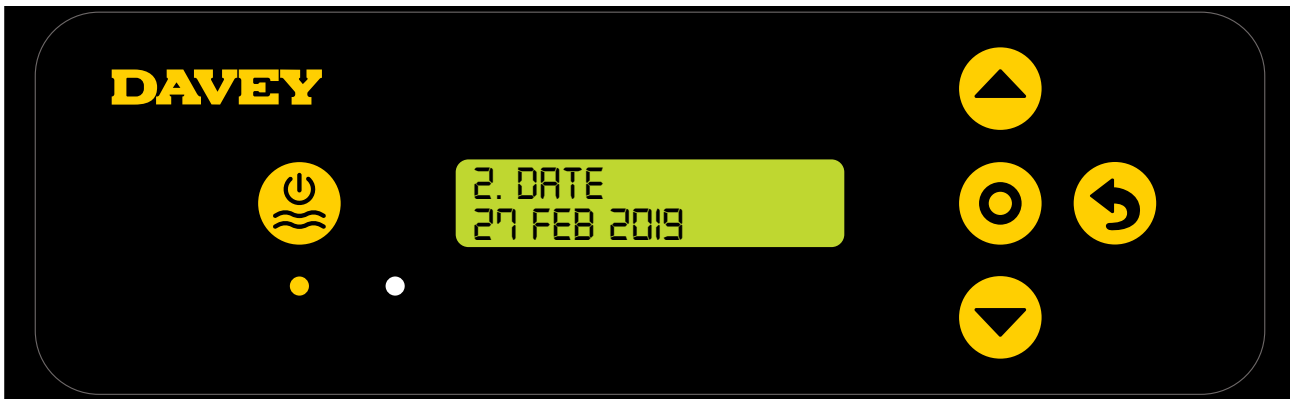

Figure 12.41

- > This screen shows the date format menu and the current date (ie 27 FEB 2019 shown);
- > Initially the date day will be flashing;
- > The date day can be changed by pressing the ▲▼ menu up/down buttons to scroll to your chosen date day;
- > Press ⓪ menu/setting select once your preferred date day is displayed;
- > If a mistake is made, the setting can be changed later.
- > Next the date month will be flashing;
- > The date month can be changed by pressing the ▲▼ menu up/down buttons to scroll to your chosen date month;
- > Press ⓪ menu/setting select once your preferred date month is displayed;
- > If a mistake is made, the setting can be changed later.
- > Next the date year will be flashing;
- > The date year can be changed by pressing the ▲▼ menu up/down buttons to scroll to your chosen date year;
- > Press ⓪ menu/setting select once your preferred date year is displayed;
- > If the ChloroMatic Nipper is left untouched for ~ 30 seconds, or the ↶ menu/setting cancel (go back) button is pushed, the display reverts to the HOME screen.

12.14 OVERRIDING LANGUAGE SETTING



Figure 12.42

- > From the HOME screen, press and hold ⓪ menu/setting select for 3 seconds.



Figure 12.43

> Press the ▲▼ menu up/down buttons to scroll down to **LANGUAGE** menu;

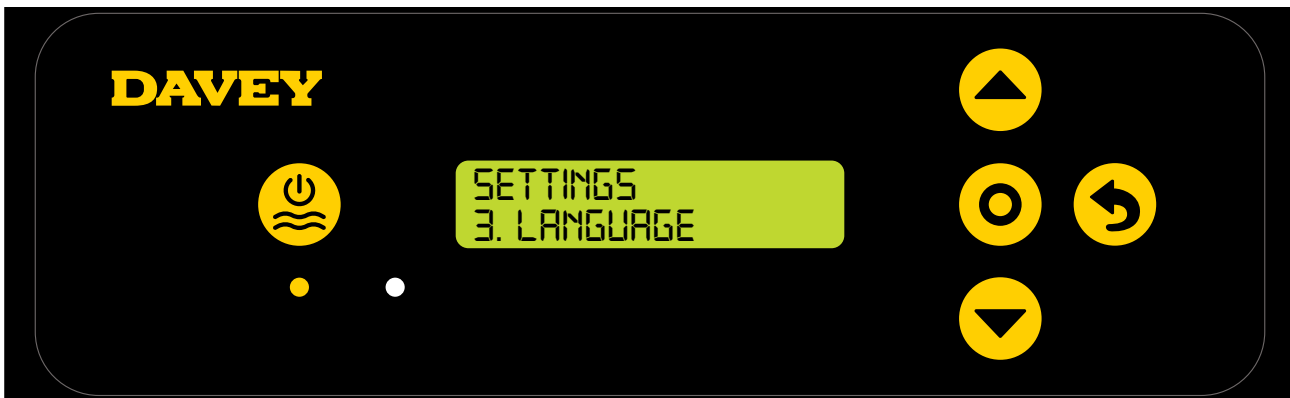

Figure 12.44

> Press ● menu/setting select;

> The current **LANGUAGE** chosen will flash;

> Use the ▲▼ menu up/down buttons to scroll to your preferred **LANGUAGE**;



Figure 12.45

> Press ● menu/setting select once your preferred **LANGUAGE** is displayed;

> If the ChloroMatic Nipper is left untouched for ~ 30 seconds, or the ↶ menu/setting cancel (go back) button is pushed, the display reverts to the **HOME** screen.

12.15 OVERRIDING TIME FORMAT SETTING

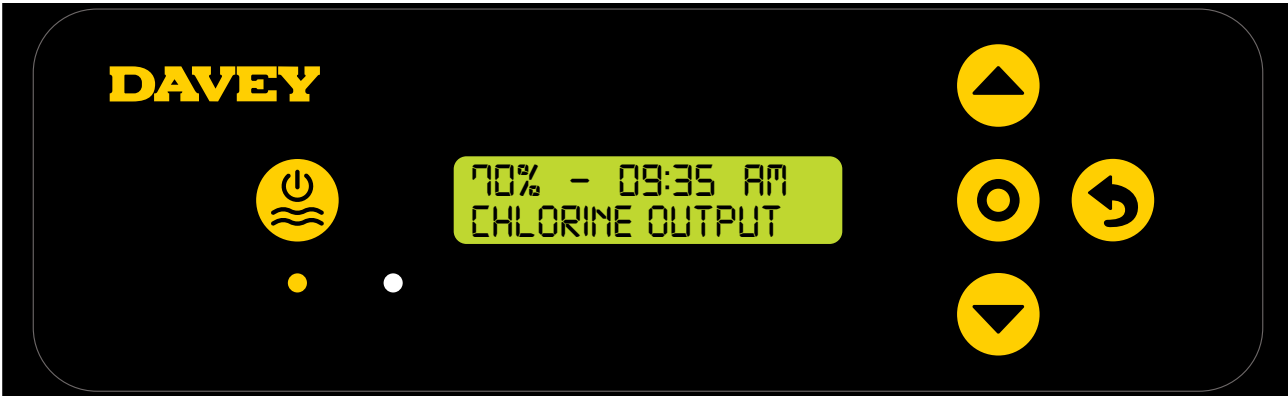

Figure 12.46

> From the **HOME** screen, press and hold  **menu/setting select** for 3 seconds.



Figure 12.47

> Press the  **menu up/down** buttons to scroll down to **TIME FORMAT** menu;





Figure 12.48

> Press  **menu/setting select**;

> The current **TIME FORMAT** chosen will flash;

> Use the  **menu up/down** buttons to scroll to your preferred **TIME FORMAT**, either 12HR, or 24HR;

> Press  **menu/setting select** once your preferred **TIME FORMAT** is displayed;

> If the ChloroMatic Nipper is left untouched for ~ 30 seconds, or the  **menu/setting cancel (go back)** button is pushed, the display reverts to the **HOME** screen.

12.16 DISPLAY ALARM HISTORY

The ChloroMatic Nipper keeps a history log for the user that registers the number of hours during which the ChloroMatic Nipper is in alarm mode. As a reminder, the cell life expectancy will be reduced if the ChloroMatic Nipper is run with salt concentrations outside of the recommended range.

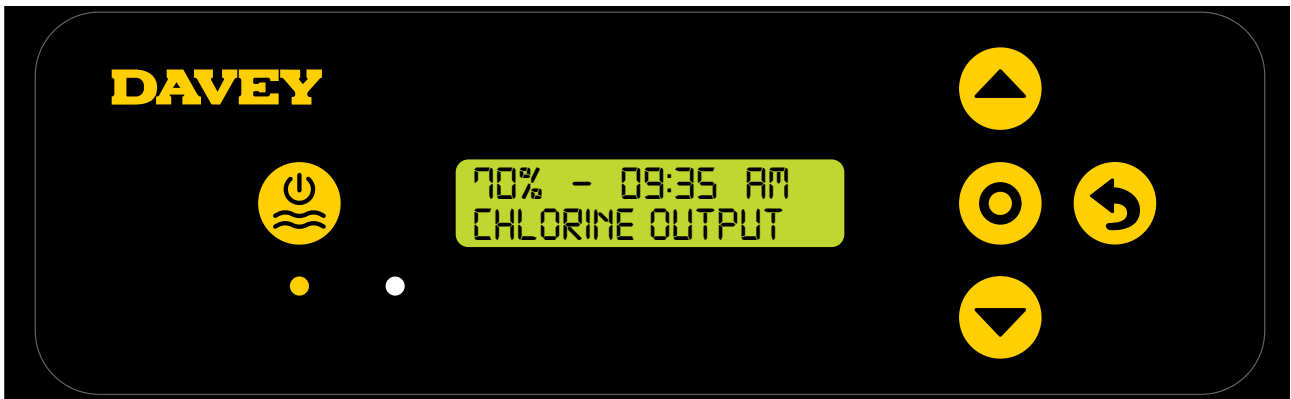

Figure 12.49

> From the **HOME** screen, press and hold  **menu/setting select** for 3 seconds.



Figure 12.50

> Press the  **menu up/down** buttons to scroll down to **ALARM HISTORY** menu;



Figure 12.51

> Press  **menu/setting select**;



Figure 12.52

> Press the  **menu up/down** buttons to toggle between cell run time and low salt time.



Figure 12.53

13. MAINTENANCE OF POWER SUPPLY

Little, or no maintenance is typically required. However, it is essential that the wall or post to which the ChloroMatic Nipper is installed be sprayed (not the ChloroMatic Nipper itself) periodically with a good surface type insect repellent, since penetration by insects may cause damage, which is not covered by your warranty.



IMPORTANT. Certain local electrical regulations state “If the supply cord is damaged, it must be replaced by a special cord available from the manufacturer or its service agent”.

14. MAINTENANCE OF THE ELECTROLYTIC CELL

The ChloroMatic Nipper cell is composed of precious materials, and although proper maintenance can prolong its life to the maximum, eventually the output will wear away its delicate coating, at which time it gradually ceases to produce chlorine. Calcium (scale) is deposited on the plates as electrolysis takes place. This build up will interfere with the flow of electrical current in the cell and thus lowers chlorine production. It is essential to inspect the cell regularly and clean when necessary. The rate at which deposits will form on the plate differs with each pool and can be influenced by the following:

- Calcium Hardness of the water;
- Water temperature;
- pH level;
- Water which has been chlorinated with calcium hypochlorite for an extended period; and/or
- Calcium in the plaster surfaces of a concrete pool.

Because these conditions vary so much, check the cell at least weekly to begin with to see if either scale or a blue/green soapy substance appears on the plates. You will then be able to determine the cleaning cycle necessary for your pool (more frequent cleaning may be required in summer). The intervals between cleaning could get longer to the point where cleaning is only necessary a couple of times each year.



NOTE: In areas with hard water, even reverse polarity systems may require occasional manual cleaning.

The life of the ChloroMatic Nipper cell varies substantially from one installation to another due to variations in operating time, water quality and composition, system and cell maintenance.

Please ensure that when cell replacement is necessary you use the correct genuine ChloroMatic Nipper replacement cell to match your system. The correct ChloroMatic Nipper replacement cells to use are shown in the table below:

Model	Replacement Cell Code
DNP15C	DES2C15REPAU
DNP15CLS	DES2C25REPAU
DNP25C	DES2C25REPAU
DNP25CLS	DES2C35REPAU
DNP35C	DES2C35REPAU

ALWAYS INSIST ON GENUINE DAVEY REPLACEMENT PARTS.

If it is necessary to replace the electrolytic cell, beware of “look-a-likes”. Only the Genuine ChloroMatic Nipper cell is designed and warranted to operate with the ChloroMatic Nipper Power Supply.

SERIOUS DAMAGE MAY RESULT TO THE ELECTRONICS INSIDE THE ChloroMatic Nipper, IF CLONE CELLS ARE USED. THIS MAY ALSO VOID WARRANTY.

14.1 TO CLEAN THE ChloroMatic Nipper CELL

Ensure that the ChloroMatic Nipper and pool pump is turned off. Failure to do so may result in the pool pump turning on while the cell is not in place. Disconnect the flow switch and cell lead from the top of the cell housing. Remove the cell from the pool return line by undoing the cell nut, taking care not to lose the o-rings.

Method one:

Add 1 part HYDROCHLORIC ACID to 10 parts WATER in a suitable container and immerse the cell in this solution. It should not take longer than a few minutes to clean, if it does the cell should be cleaned more frequently. If the build – up is not excessive it may be possible to clean the cell plates with a jet of running water. Return the cell to its housing and connect leads to the head assembly.

Method two:

As an alternative, an approved commercial cell cleaning solution can be used a number of times effectively.



NOTE: Always add acid to water. Never add water, to acid. Always wear eye protection and rubber gloves. Always clean the cell in a well-ventilated area.

14.2 RE-INSTALLING CELL AFTER CLEANING OR REPLACEMENT

When re-installing the ChloroMatic Nipper cell into the housing, ensure that the cell locking nut is tight. Do this by turning on the pool pump once fitted, then checking for leaks.

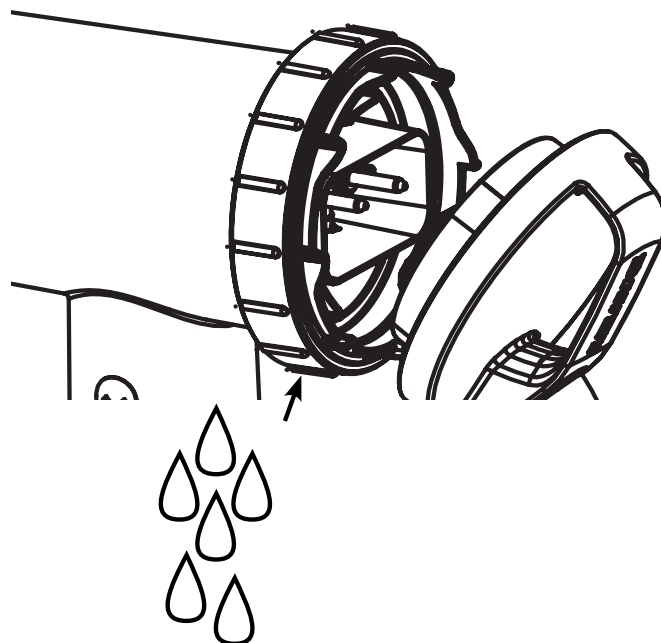

If there is a leak, remove the lock nut and inspect the o-ring for debris, or damage. Then re-try. Before re-fitting the cell connectors, ensure that the terminals are dry.

14.3 SAFETY DEVICE

Hydrogen Gas is a by-product of the chlorine producing process. A Flow Switch has been supplied with the ChloroMatic Nipper, which will stop output if low or no flow is detected. The ChloroMatic Nipper system will run to flows down to 4.8m³/h (80L/min).

15. DAY TO DAY OPERATION

Four prime rules must be observed if your unit is to give the best possible service:

15.1 STABILISER

The importance of pool stabiliser cannot be over – emphasised. It is essential in helping retain chlorine in your pool. Chlorine is rapidly dissipated by sunlight and the use of stabiliser will reduce this dissipation substantially. Without stabiliser, it may be necessary to run the Unit for up to three times as long!

Stabiliser should be added at the rate of 500 grams for every 10,000 litres of water. Stabiliser should be maintained at a level of 25-50ppm. If a ORP controller is used, Stabiliser should be maintained at a level of 15-25ppm. Before adding more stabiliser, have your pool water analysed at your pool shop to ensure that you do not add too much. **(FOR OUTDOOR POOLS ONLY, INDOOR DO NOT REQUIRE STABILISER).**

15.2 pH AND TOTAL ALKALINITY

A correct pH level must be maintained to prevent problems such as black spot, staining, cloudy water, etc. An incorrect pH level can damage the pool. Correct pH levels are as follows; Fibreglass – 7.2 to 7.4; Concrete & tiled – 7.4 to 7.6 If you allow the pH level to rise to 8.0 or above, the chlorine required could be as much as three times the normal amount, in order to correctly sanitise the pool.

Total Alkalinity should not be confused with pH. Although the two are closely related, Total Alkalinity determines the speed and ease of pH change. The ideal range is 80 – 150 ppm or, refer to your pool professional.

You should use a test kit which includes a test for Total Alkalinity. Low Total Alkalinity can cause unstable pH levels. An inability to keep the pH constant may cause staining, etching and corrosion of metals. High Total Alkalinity will cause constantly high pH levels and tends to encourage Calcium scaling.

15.3 TDS LEVELS



WARNING: Some people recommend that you put salt directly in the skimmer box. This is a poor practice as it allows very high concentrations of salt to be passed through your filtration and other pool equipment.

Salt is the essential element by which your ChloroMatic Nipper operates with. Insufficient Salt will damage your cell.

RECOMMENDED SALT LEVEL RANGE

Nipper model	Operating salt level	Add salt alarm
DNP15CLS, DNP25CLS	1,500 – 6,000ppm	~ 1,500ppm
DNP15C, DNP25C, DNP35C	3,000 – 6,000ppm	~ 3,000ppm



WARNING: Do not add Hydrogen Peroxide to pool water or through swimming pool hydraulic, or sanitiser system. Use of Hydrogen Peroxide will void warranty on Davey products.

Salt is NOT used up in the chlorination process, or by evaporation. It is only lost through dilution caused from: backwashing, splash-out, overflow, leakage from the pool, or plumbing. Heavy rain can dilute the salt levels in your pool therefore, salt levels should be checked during these events.

Low salt levels will destroy the coating on the cell plates and will void all Warranty.

The ChloroMatic Nipper has a built-in warning indicator to minimise damage resulting from insufficient salt levels however, the ultimate responsibility is on the owner to ensure adequate salt levels are maintained all year round.

15.4. RUNNING TIMES

These instructions cover Nipper for residential use only.

If you run your Sanitiser on maximum output for, 24 hours a day, or for longer periods, the cell life will be greatly reduced. It is important that the correct model ChloroMatic Nipper has been installed on your pool. Many models are available from Davey to cope with small courtyard pools up to commercial size pools. (Consult your local Nipper Dealer for more information).

Note: The ChloroMatic Nipper warranty does not apply to commercial or semi-commercial applications, i.e. where the pool chlorine demand is far in excess of a typical residential pool.

16. CHLORINE PRODUCTION

The ChloroMatic Nipper must be run daily to generate sufficient chlorine to sanitise the pool. During summer a typical installation would require eight hours per day of chlorination. Depending on when you choose to run the ChloroMatic Nipper, it is best to test the residual Chlorine in the pool at the point where you would anticipate the levels be at their lowest. At that chosen time of the day, if the residual Chlorine level from your test is reading too high, reduce the ChloroMatic Nipper **CHLORINE OUTPUT**. Alternatively, if the residual Chlorine level from your test is reading too low, increase the ChloroMatic Nipper **CHLORINE OUTPUT** (refer to page 16). Correct chemical balances (see page 39) are critical to ensure the ChloroMatic Nipper performs correctly.

In cooler times of the year, it's typically possible to reduce running hours of the ChloroMatic Nipper. Follow instruction from your pool professional. Chlorine output can also be reduced throughout this time by entering **WINTER MODE**, (see page 26).

16.1 "SHOCK" TREATMENT

Periodically, especially during extremely hot conditions, it may be necessary to boost the chlorine level in the pool. This can be achieved by selecting **BOOST MODE**, which will run the system on full for 24 hours, (see page 22). Alternatively, add either liquid, or granulated chlorine. If granulated chlorine is added, the cell must be checked regularly, since the additives from this product can clog the electrodes.

16.2 CHLORINE TYPES AND COMPARISONS / MAX POOL SIZE

Many chlorinator manufacturers calibrate their units to compare with 65% granulated chlorine, making it necessary to adjust their readings to a lower level in order to determine true chlorine production. Below is a comparison table of the available types of chlorine used to sanitise pools.

ChloroMatic Nipper Model	Production Maximum (g/hr 100%)	Production (g/hr 65% equivalent)	Chlorine produced over 8 hours (grams 100%)	Maximum Pool Size		
				Cool Climates <25°C	Temperate Climates 25°C to 30°C	Hot & Tropical Climates >30°C
DNP15C(LS)	15	23	120	75m ³	58m ³	46m ³
DNP25C(LS)	25	38	200	125m ³	96m ³	80m ³
DNP35C	35	53	280	175m ³	134m ³	112m ³



NOTE: The appropriate ChloroMatic Nipper for your pool is dependent on the local climate, bather load of the pool and running times. Please note that the ChloroMatic Nipper cell life can be increased with shorter running times during winter and lower output settings. Davey recommends the ChloroMatic Nipper be run for between 6 - 8 hours a day during summer, and 4 hours during winter.

17. GENERAL INFORMATION

17.1 POOL WATER CHEMISTRY INSTRUCTIONS

POOL WATER BALANCE	Free Chlorine (ppm)	pH	Total Alkalinity TA (ppm)	Calcium Hardness (ppm)	Stabiliser - Cyanuric Acid (ppm)	Recommended salt Levels (ppm)
Ideal reading / range	1.5 - 3	Concrete & tiled pools 7.4-7.6 Other surfaces 7.2-7.4	80 - 150	Concrete & tiled pools 200-275 Other surfaces 100-225	25-50ppm (15-25ppm if used with an ORP controller) Not to be used in indoor pools.	Depends on model (see page 36)
To increase	Increase output of sanitiser. Add chlorine. Increase filtration time.	Add Soda Ash (Sodium Carbonate)	Add Buffer (Sodium Bicarbonate)	Add Calcium Chloride	Add Cyanuric Acid	Add salt
To decrease	Decrease output of sanitiser. Decrease filtration time.	Add Hydrochloric Acid	Add Hydrochloric Acid or Dry Acid	Partially drain & refill pool with lower hardness water to Dilute	Partially drain & refill pool to dilute	Partially drain & refill pool to dilute
Frequency of testing	Weekly	Weekly	Weekly	Weekly	Regularly	Regularly

18. TROUBLE SHOOTING

No Chlorine Production - Check for:

1. No power to system
2. Insufficient flow from pump
3. Control set to manual off
4. **CHLORINE OUTPUT** set to "0" setting
5. Dirty cell
6. Filter needs back washing
7. Flow switch not connected or damaged
8. Salt level too low triggering low salt cut-out
9. Main house fuse blown
10. Pump faulty

Low Chlorine Production - Check for:

1. Dirty cell - clean if required
2. Filter needs back washing
3. Pool stabiliser too low
4. pH too high
5. Salt level too low
6. Running time inadequate
7. **CHLORINE OUTPUT** set too low
8. **POOL COVER MODE** accidentally turned on
9. **SPA COVER MODE** accidentally turned on
10. **WINTER MODE** accidentally turned on
11. Pump faulty
12. Cell failing

18. SPARE PARTS

18.1 SPARE PARTS EXPLODED DIAGRAM

15g/h system	DES2-15E	DES2-15US	DNP15C
15g/hr low salt system	DES2-15EL	DES2-15USL	DNP15CLS
25g/h system	DES2-25E	DES2-25US	DNP25C
25g/h low salt system	DES2-25EL	DES2-25USL	DNP25CLS
35g/h system	DES2-35E	DES2-35US	DNP35C

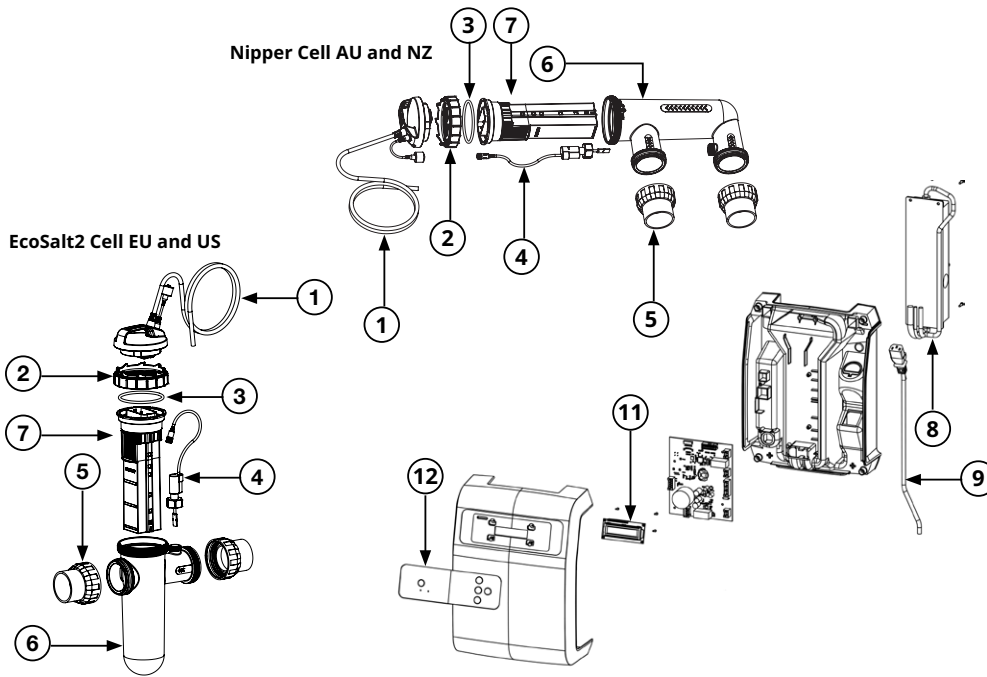

ITEM	NOTES	DESCRIPTION	QTY REQ'D	PART NO.
1		Cell cable plug assy	1	33021SP
2		Cell lock ring	1	16058SP
3		O-ring cell head	1	403377SP
4		Paddle switch	1	16102-3SP
5		Barrel union assy 40/50mm AU	2	48773BSP
5		Barrel union assy 63mm EU	2	48722B-1SP
5		Barrel union assy 50mm US	2	48722BSP
6		Nipper cell body AU	1	16116SP
6		Ecosalt 2 cell body EU US	1	16056SP
7		Replacement cell DNP15C	1	DES2C15REPAU
7		Replacement cell DNP25C, DNP15CLS	1	DES2C25REPAU
7		Replacement cell DNP35C, DNP25CLS	1	DES2C35REPAU
7		Replacement cell DES2-15E & US	1	DES2C15REP
7		Replacement cell DES2-15EL & USL, DES2-25E & US	1	DES2C25REP
7		Replacement cell DES2-25EL & USL, DES2-35E & US	1	DES2C35REP
8		Power supply 15g (L) with screws	1	33186SP
8		Power supply 25g (L) and 35g with screws	1	33187SP
9		Power lead US	1	16190SP
9		Power lead AU	1	403370SP
9		Power lead EU	1	403371SP
11		LCD screen PCB with screws	1	33188SP
12		Control panel decal	1	16047SP
-		Cell blanking cap w/oring	1	33189SP
-		Reducing bush - EU only	2	403393SP
-	AU	Nipper 15g Control Box REP	1	DNP15CCB
-	AU	Nipper 15g LS Control Box REP	1	DNP15CLSCB
-	AU	Nipper 25g Control Box REP	1	DNP25CCB
-	AU	Nipper 25g LS Control Box REP	1	DNP25CLSCB
-	AU	Nipper 35g Control Box REP	1	DNP35CCB
-	EU	Ecosalt2 15g Control Box REP	1	DES2-15ECB
-	EU	Ecosalt2 15g LS Control Box REP	1	DES2-15ELCB
-	EU	Ecosalt2 25g Control Box REP	1	DES2-25ECB
-	EU	Ecosalt2 25g LS Control Box REP	1	DES2-25ELCB
-	EU	Ecosalt2 35g Control Box REP	1	DES2-35ECB

Davey Warranty

Davey Water Products Pty Ltd (Davey) warrants all products sold will be (under normal use and service) free of defects in material and workmanship for a minimum period of one (1) year from the date of original purchase by the customer as marked on the invoice, for specific warranty periods for all Davey products visit daveywater.com.

This warranty does not cover normal wear and tear or apply to a product that has:

- been subject to misuse, neglect, negligence, damage or accident
- been used, operated or maintained other than in accordance with Davey's instructions
- not been installed in accordance with the Installation Instructions or by suitably qualified personnel
- been modified or altered from original specifications or in any way not approved by Davey
- had repairs attempted or made by other than Davey or its authorised dealers
- been subject to abnormal conditions such as incorrect voltage supply, lightning or high voltage spikes, or damages from electrolytic action, cavitation, sand, corrosive, saline or abrasive liquids,

The Davey warranty does not cover replacement of any product consumables or defects in products and components that have been supplied to Davey by third parties (however Davey will provide reasonable assistance to obtain the benefit of any third-party warranty).

To make a warranty claim:

- If the product is suspected of being defective, stop using it and contact the original place of purchase. Alternatively, phone Davey Customer Service or send a letter to Davey as per the contact details below
- Provide evidence or proof of date of original purchase
- If requested, return the product and/or provide further information with respect to the claim. Returning the product to the place of purchase is at your cost and is your responsibility.
- The warranty claim will be assessed by Davey on the basis of their product knowledge and reasonable judgement and will be accepted if:
 - a relevant defect is found
 - the warranty claim is made during the relevant warranty period; and
 - none of the excluded conditions listed above apply
- The customer will be notified of the warranty decision in writing and if found to be invalid the customer must organise collection of the product at their expense or authorise its disposal.

If the claim is found to be valid Davey will, at its option, repair or replace the product free of charge.

The Davey warranty is in addition to rights provided by local consumer law. You are entitled to a replacement or refund for a major failure and compensation for any other reasonably foreseeable loss or damage. You are also entitled to have the goods repaired or replaced if the goods fail to be of acceptable quality and the failure does not amount to a major failure.

For any internet connected products the consumer is responsible for ensuring a stable internet connection. In the event of a network failure the consumer will need to address the concern with the service provider. Use of an App is not a substitute for the User's own vigilance in ensuring the product is working to expectation. Use of a Smart Product App is at the User's own risk. To the fullest extent permitted by law Davey disclaims any warranties regarding the accuracy, completeness or reliability of App data. Davey is not responsible for any direct or indirect loss, damage or costs to the User arising from its reliance on internet connectivity. The User indemnifies Davey against any claims or legal actions from them or others relying on internet connectivity or App data may bring in this regard.

Products presented for repair may be replaced by refurbished products of the same type rather than being repaired. Refurbished parts may be used to repair the products. The repair of your products may result in the loss of any user-generated data. Please ensure that you have made a copy of any data saved on your products.

To the fullest extent permitted by law or statute, Davey shall not be liable for any loss of profits or any consequential, indirect or special loss, damage or injury of any kind whatsoever arising directly or indirectly from Davey products. This limitation does not apply to any liability of Davey for failure to comply with a consumer guarantee applicable to your Davey product under local laws and does not affect any rights or remedies that may be available to you under local laws.

For a complete list of Davey Dealers visit our website (daveywater.com) or call:

DAVEY

Davey Water Products Pty Ltd
Member of the GUD Group
ABN 18 066 327 517

daveywater.com

AUSTRALIA

Customer Service Centre

6 Lakeview Drive,
Scoresby, Australia 3179
Ph: 1300 232 839
Fax: 1300 369 119
Email: sales@davey.com.au

NEW ZEALAND

Customer Service Centre

7 Rockridge Avenue,
Penrose, Auckland 1061
Ph: 0800 654 333
Fax: 0800 654 334
Email: sales@dwp.co.nz

© Davey is a registered trademark of Davey Water Products Pty Ltd. © Davey Water Products Pty Ltd 2022.

P/N 403603-12

*** Installation and operating instructions are included with the product when purchased new. They may also be found on our website.**